











Skříňka signalizace ochran H271 (klapkovník) ř. 162, 163

Napětové relé Relé HV a trolejového napětí	Časové relé poruchy ventilace (20s)	Diferenciální ochr. trakčního obvodu	Diferenciální ochr. Pomocných pohonů	Nadproudová ochrana topení vlaku
 K04 K142	 K117	 K03	 K11	 K09
 K04.M	 K05.M	 K21	 K22	 K04.L K05.L
Nadproudová ochrana MS1 trakce	Nadproudová ochrana MS2 trakce	Skruzova ochrana MS1 trakce	Skruzova ochrana MS2 trakce	Nadproud MS1 brzda Nadproud MS2 brzda

Centrální napáječ 48/115V 400Hz ř. 162, 163

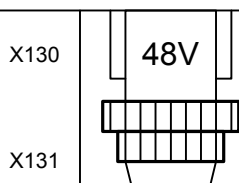
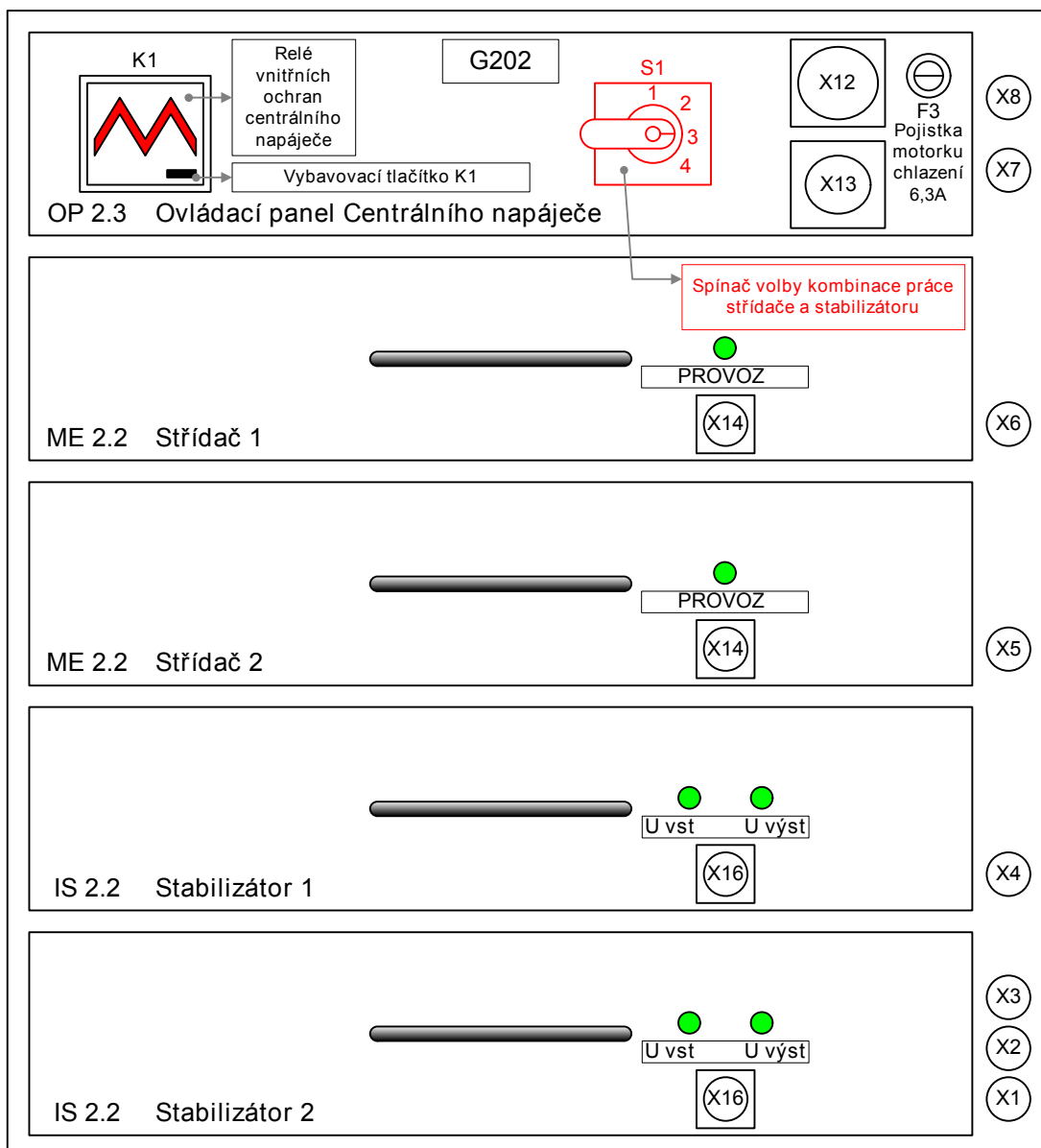

Poloha přepínače	Zapojen	Zapojen
1	střídač 1	Stabilizátor 1
2	střídač 2	stabilizátor 2
3	střídač 1	stabilizátor 2
4	střídač 2	stabilizátor 1